

Temperature controller 1/16 DIN - 48 x 48 mm gamma**due**[®] series M4 line

Flexible, easy and comprehensive

This 48x48 size controller of the gamma**due**[®] series, is suitable for a wide range of applications. It performs Heat/Cool control and provides on auxiliary current transformer input. Easy configuration and simple operating method are merged with the typical characteristics

of more complex devices like: autotune, IP65 front panel protection, serial communications, analogue control output, Auto/Man, custom linearisation, transmitter power supply, Start-up and Timer special functions.

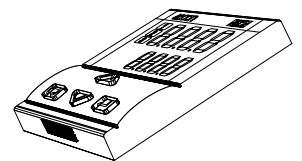
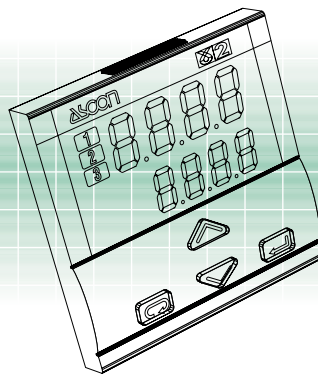
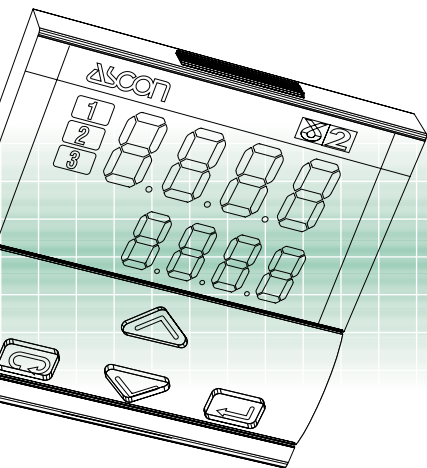
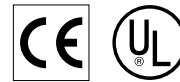

E

ISO 9001 Certified

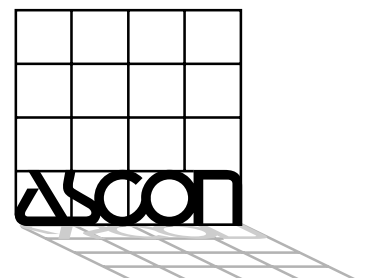

ASCON spa

20021 Bollate - (Milano) Italy - Via Falzarego, 9/11 - Tel. +39 02 333 371 - Fax +39 02 350 4243
<http://www.ascon.it> e-mail info@ascon.it



Your needs	Our solutions
Heaters failure	Heater break alarm with current transformer
Both heating and cooling functions	Heat/Cool double action
Easy replacement and quick start-up	Configuration by simple to use codes
Correct tuning for any condition	Automatic selection between two different tuning methods
Alarm signalling	Absolute, band and deviation alarms, Latching/Blocking
Interfacing with other devices	Serial communications at 9600 baud Modbus/Jbus protocol, analogue retransmission output
Quick learning	Every model has the same operating method
Ergonomic compatibility with other devices	Two colours: beige or darkgrey front panels
Environmental protection	IP65 front panel protection (indoor, dust and water protection)
Easy to use	Ergonomic keypad, clear and comprehensive display
Noise immunity	Electromagnetic compatibility
Universal input signals, linear as well as non-linear	Configurable input (TC, RTD, mA, Volt and ΔT , infrared sensor, "custom" linearisation)
Costs reduction	Built-in Timer and Start-up functions
Reliability and safety	CE compatibility, ASCON is ISO 9001 certified, 3 years warranty
Technical support	Technical application assistance from ASCON sales and after sales service

Resources **Operating mode**

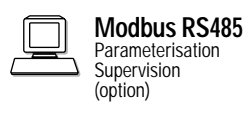
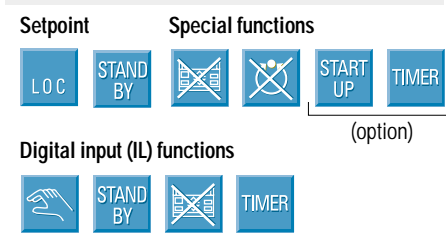
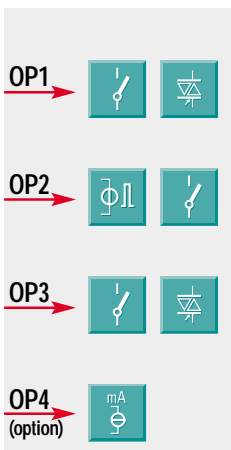
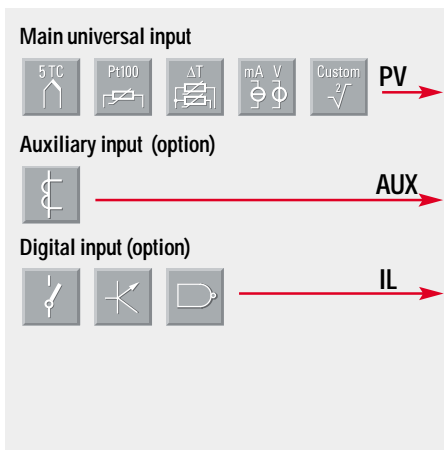

	Control *	Alarms
1 Single action	OP1	OP2 OP3
2 Single action	OP2	OP1 OP3
3 Double action	OP1 OP3	OP2
4 Double action	OP1 OP2	OP3
5 Double action	OP2 OP3	OP1

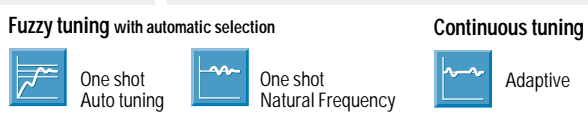

* Each control output can be replaced by the OP4 analogue output

Technical data

Features at env. 25°C	Description			
Total configurability	From keypad or serial communications, the user selects: type of input - associated functions and corresponding outputs - type of control algorithm - type of output and safe conditions - alarm types and functionality - control parameter values			
PV input (for signal ranges see table 1)	Common characteristics	A/D converter with 50.000 points Update measurement time : 0.2 sec Sampling time : 0.5 sec Input shift : + 60 digits Input filter : 1...30 sec (OFF= 0)		
	Accuracy	0.25% ± 1 digit (T/C and RTD) 0.1% ± 1 digit (mA and mV)	Between 100 and 240V ~ error is minimal	
	Resistance thermometer (for ΔT: R1+R2 must be <320Ω)	Pt100Ω at 0°C (IEC 751) °C / °F selectable	2 or 3 wire connection	Line: 20Ω max (3 wire) Thermal drift 0.35°C/10°C env. T. <0.35°C/10Ω line resist.
	Thermocouple	L, J, T, K, S (IEC 584) °C / °F selectable	Internal cold junction compensation	Line: 150Ω max Thermal drift <2μV/°C env. T. <5μV/10Ω line resist.
	DC input (current)	0/4...20mA with 2.5Ω ext. Shunt Rj > 10MΩ	Engineering units, floating decimal point, Low Range -999...9999 High Range -999...9999 100 digits minimum	Input drift: <0.1% / 20°C env. T.
	DC input (voltage)	0/10...50mV, Rj > 10MΩ		
Auxiliary input	CT current transformer	50 or 100mA input hardware selectable	Current visualization 10...200 A with 1A resolution and Heater break alarm	
Digital input (option)	The closure of the external contact produces any of the following actions:		Auto/Man mode change, Stand-by Setpoint activation, keypad lock, Timer start	
Operating modes	1 double action PID loop or ON/OFF with 1 or 2 alarms			
Control mode	Algorithm	P.I.D. with overshoot control or ON/OFF		
	Proport. band (P)	0.5...999.9%		
	Integral time (I)	0.1...100.0 min		
	Derivative time (D)	0.01...10.00 min		
	Error band	0.1...10.0 digit		
	Cycle time	1...200 sec.		
	Dead band	-10.0...10.0		
	Relative cool gain	0.1...10.0		
	Cool cycle time	1...200 sec.		
	Overshoot control	0.01...1.00		
High limit	100.0...10.0% (heat) -100.0...-10.0% (cool)			
Hysteresis	0.1...10.0%			
OP1 output	SPST relay N.O., 2A/250V~ for resistive load Triac, 1A/250V~ for resistive load			
OP2 output	SSR drive not isolated: 5V~, ± 10%, 30mA max SPST relay N.O., 2A/250V~ for resistive load			
OP3 output	SPST Relay N.O., 2A/250V~ for resistive load Triac, 1A/250V~ for resistive load			
OP4 (option) analogue control output	Galvanically isolated: 500V~/1min Resolution: 12bit (0.025%) Accuracy: 0.1%		In current 0/4...20mA 750Ω/15V max	
AL2-AL3 alarms	Hysteresis 0.1 ... 10.0% of range			
	Action	Active high	Action type	Deviation threshold ± range
		Active low		Band threshold 0...range
	Special functions		Sensor break, Heater break, Loop break, Latching/Blocking	
Setpoint	Local and stand-by selectable by digital input or serial communications			
	Up and down ramps		0.1...999.9 digit/min (OFF = 0)	
	Low limit	from low range to high limit		
One-shot Fuzzy-Tuning	Depending on the process condition, the controller applies the best method		Step response	
			Natural frequency	
Auto/Man Station	Standard with bumpless function, by keypad, digital input or serial communications			

Input type	Scale range
RTD	-99.9...300.0 °C
	-99.9...572.0 °F
Pt100Ω a 0°C	-200...600 °C
	-328...1112 °F
T/C type L	0...600 °C
Fe-Const.	32...1112 °F
T/C type J	0...600 °C
Fe-Cu 45% Ni	32...1112 °F
T/C type T	-200...400 °C
Cu - CuNi	-328...752 °F
T/C type K	0...1200 °C
Cromel Alumel	32...2192 °F
T/C type S	0...1600 °C
Pt10%Rh-Pt	32...2912 °F
0/4...20 mA	Configurable engineering units
0/10...50 mV	mA, mV, V, bar, psi, Rh, ph
mV Custom scale	On request

Table 1: PV input

Special functions

To improve the instrument performance and to reduce the wiring and installation costs, two special functions are available:

- Start-up

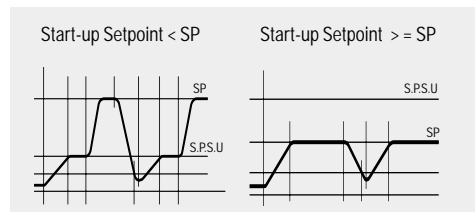

- Timer

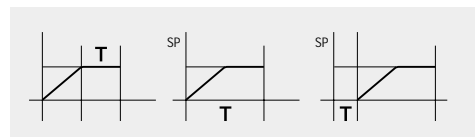

The use of these functions avoids additional device installation (e.g. external timer), therefore allowing a significant costs reduction.

Moreover there are:

- **Keypad lock/unlock** function, to avoid incorrect operator actions
- **Outputs lock/unlock** function, at any moment it is possible to stop the control action, but not the process variable display, without switching-off the power supply.

Technical data

Features at env. 25°C	Description	
Ser. comm.s (opt.)	RS 485 isolated, Modbus/Jbus protocol 1200, 2400, 4800, 9600 bit/sec, two wires	
Aux. power sup.	(opt.) +18V±20%, 30mA max for external transmitter supply	
Operational safety	Measure input	Detection of out of range, short circuit or sensor break with automatic activation of the safety strategies and alerts on display
	Control output	Safety value: 0...100%. (-100...100% for Heat/Cool mode) (user enabled/disabled).
	Parameters	A non volatile memory stores for unlimited time all the parameter and configuration values
	Password	A password protects the access to the instrument configuration parameterisation
General characteristics	Power supply	100-240V~ (-15% +10%) 50/60Hz or 24V~ (-25% +12%), 50/60Hz and 24V- (-15% +25%). Power consumption 2.6 W max
	Safety	Compliance EN61010-1 (IEC 1010-1), installation class 2 (2500V), pollution class 2, class II instrument
	Electromagnetic compatibility	Compliance to the CE standards for industrial system and equipment
	UL and cUL Omologation	File E176452
	Protection EN60529 (IEC 529)	IP65 front panel
	Overall dimensions	1/16 DIN - 48 x 48, depth 120 mm, weight 130g appr. Panel cut-out: 45 ^{+0.6} x 45 ^{-0.6} mm

Electrical wirings

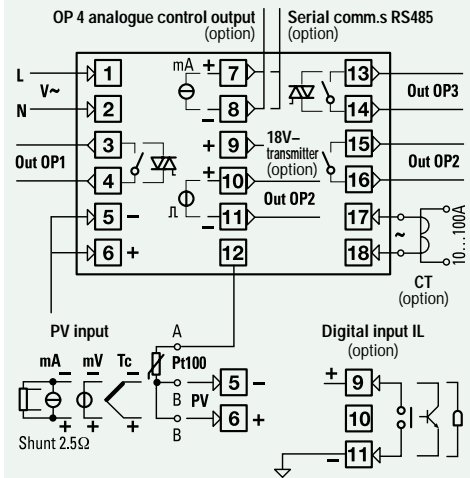

Ordering codes

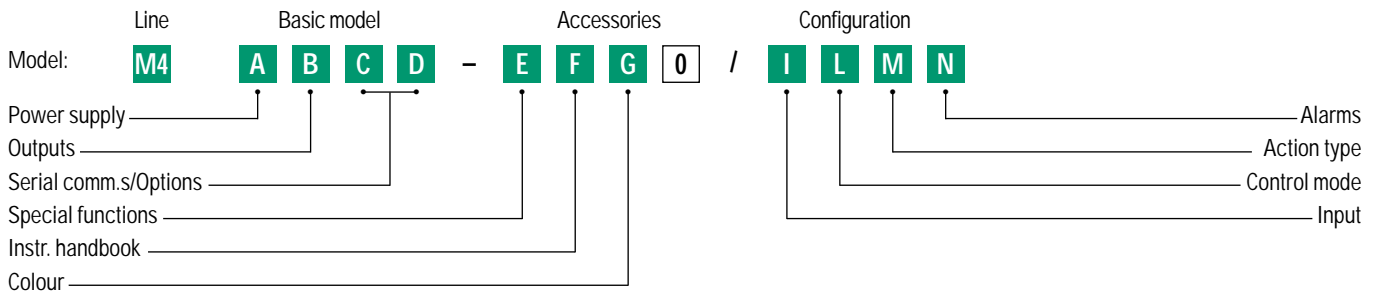

Power supply		A
100-240V~ (-15% +10%)		3
24V~ (-25% +12%) or 24V- (-15% +25%)		5
Output OP1-OP3		B
Relay-Relay		1
Relay-Triac		2
Triac-Relay		4
Triac-Triac		5
Serial comm.s/IL	Options	C D
	None	0 0
	Current Transformer input (CT)	0 3
Not fitted	Transmitter power supply + 18V	0 6
	+ Analogue control output	0 7
	+ CT	0 8
	+ Analogue control output+ CT	0 9
RS 485 Modbus/Jbus protocol	None	5 0
	Transmitter power supply + CT	5 6
		5 8
Digital input	None	9 0
	CT	9 3
	Analogue control output + CT	9 9
Special functions		E
Not fitted		0
Start-up + Timer		2
Instruction handbook		F
Italian-English (std)		0
French-English		1
German-English		2
Spanish-English		3
Front case colour		G
Dark (std)		0
Beige		1

Input type	Range scale	I
RTD Pt100 IEC751	-99.9...300.0 °C -99.9...572.0 °F	0
RTD Pt100 IEC751	-200...600 °C -328...1112 °F	1
TC L Fe-Const DIN43710	0...600 °C 32...1112 °F	2
TC J Fe-Cu45% Ni IEC584	0...600 °C 32...1112 °F	3
TC T Cu-CuNi	-200...400 °C -328...752 °F	4
TC K Chromel -Alumel IEC584	0...1200 °C 32...2192 °F	5
TC S Pt10%Rh-Pt IEC584	0...1600 °C 32...2912 °F	6
0...50mV linear	Engineering units	7
10...50mV linear	Engineering units	8
mV "Custom" scale	On request	9

Output configuration	L
P.I.D.	control OP1 / alarm AL2 on OP2 control OP2 / alarm AL2 on OP1
On - Off	control OP1 / alarm AL2 on OP2 control OP2 / alarm AL2 on OP1
Heat / Cool action	control OP1-OP3 / alarm AL2 on OP2 control OP1-OP2 / alarm AL2 on OP3 control OP2-OP3 / alarm AL2 on OP1

Single control action type	Heat/Cool double control action	M
Reverse	Linear cool	0
Direct	On-Off cool	1

AL2 type and function	N
Disabled	0
Sensor break/Loop break alarm	
Absolute	active high active low
Deviation	active high active low
Band	active out active in
Heater break by CT (if present)	active during ON output state active during OFF output state

If not differently specified the controller will be supplied with standard version

Model: M4 3100-0000